

REVISIONS			
REV	DESCRIPTION	DATE	APPROVED

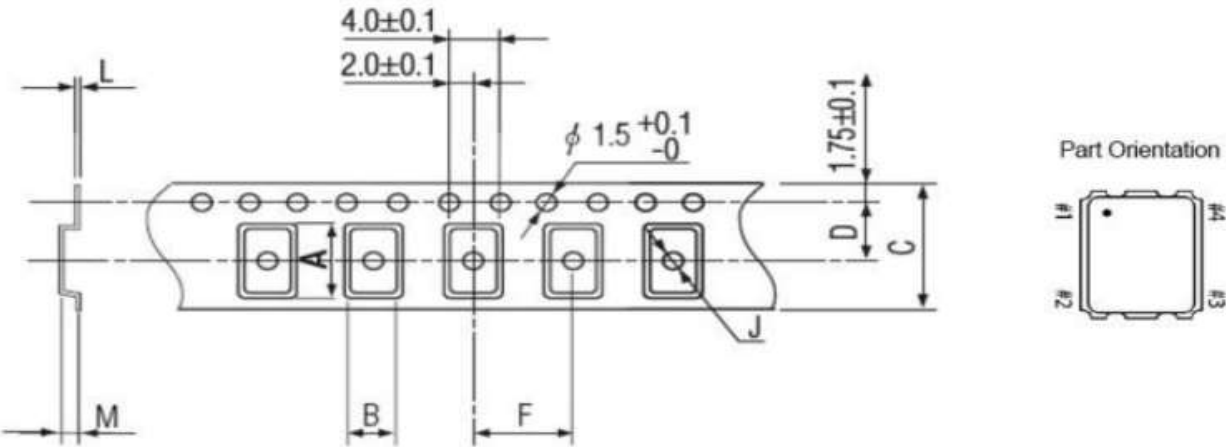

A	B	C	D	F	J	L	M	Reel Dia.	Qty/Reel
3.4	2.7	8.0	3.5	4.0	1.0	0.25	1.4	178	1000pcs

ECS INC. INTERNATIONAL 15351 W. 109th Street Lenexa, KS 66219 (913) 782-7787		
TITLE ECS-3225SMVQ Tape Specification		
SIZE A	DWG NO.	REV -
CAGE CODE: 1G8B7		SHEET 1 OF 1

Dimensions in mm